

EDD-E

FAKRO[®]

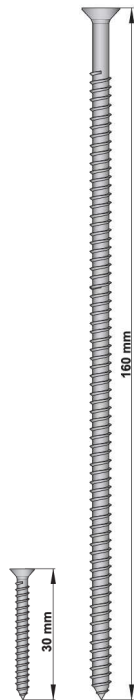

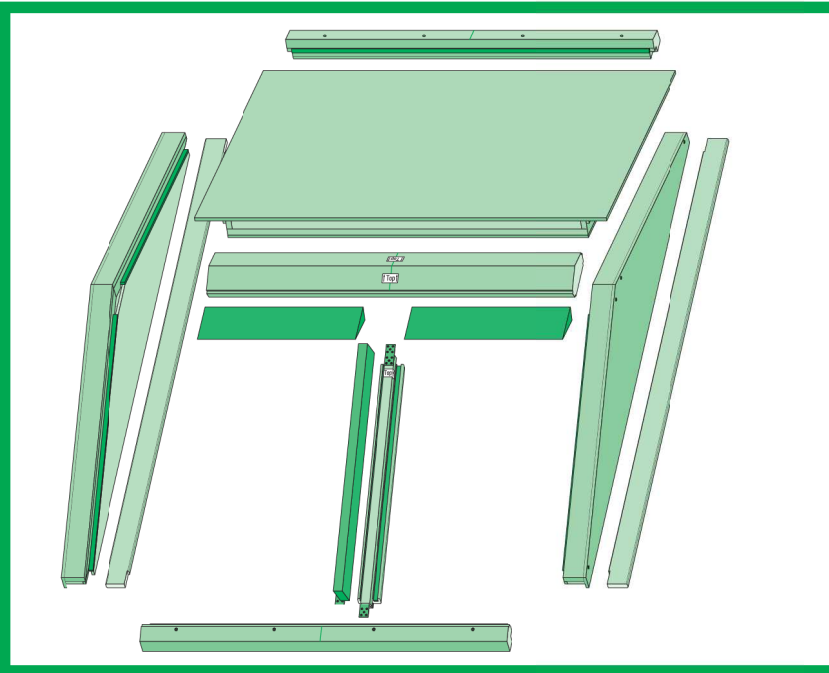

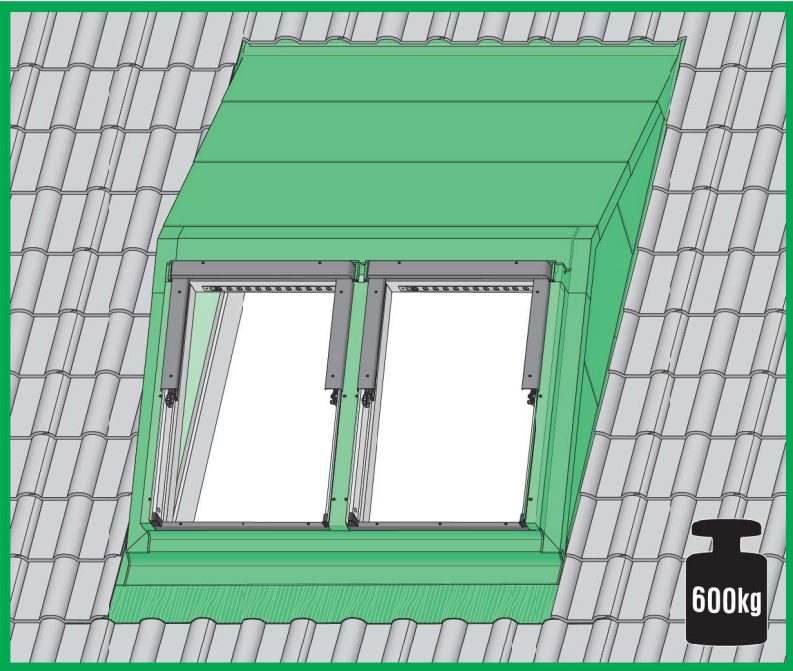
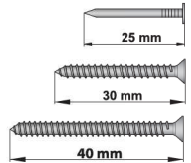
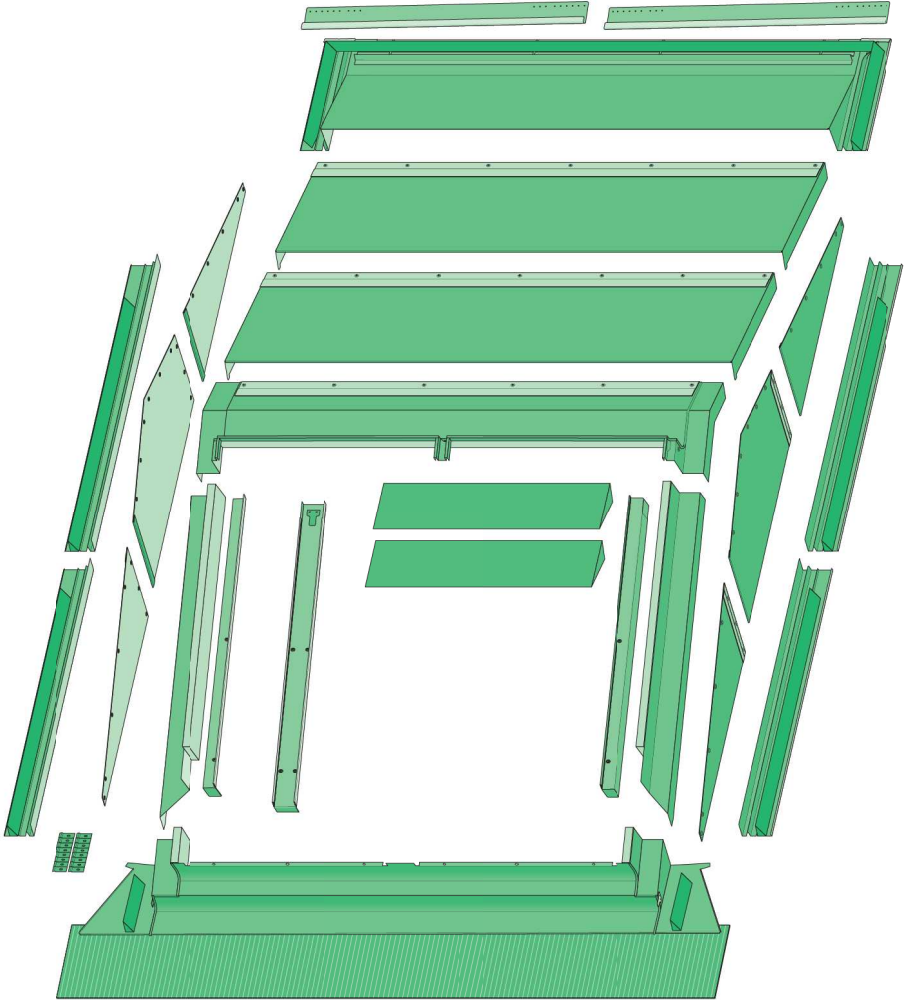
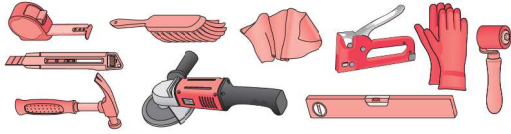
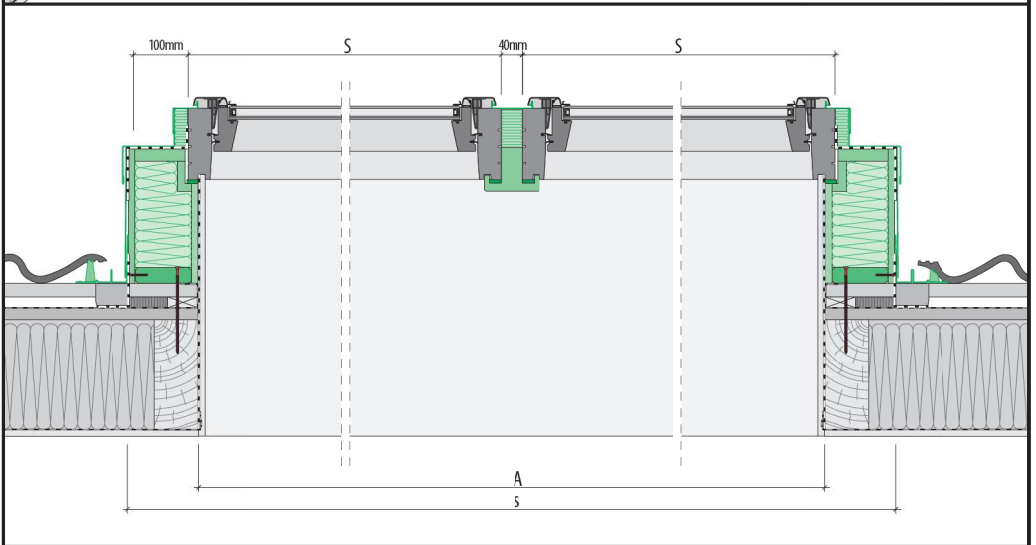
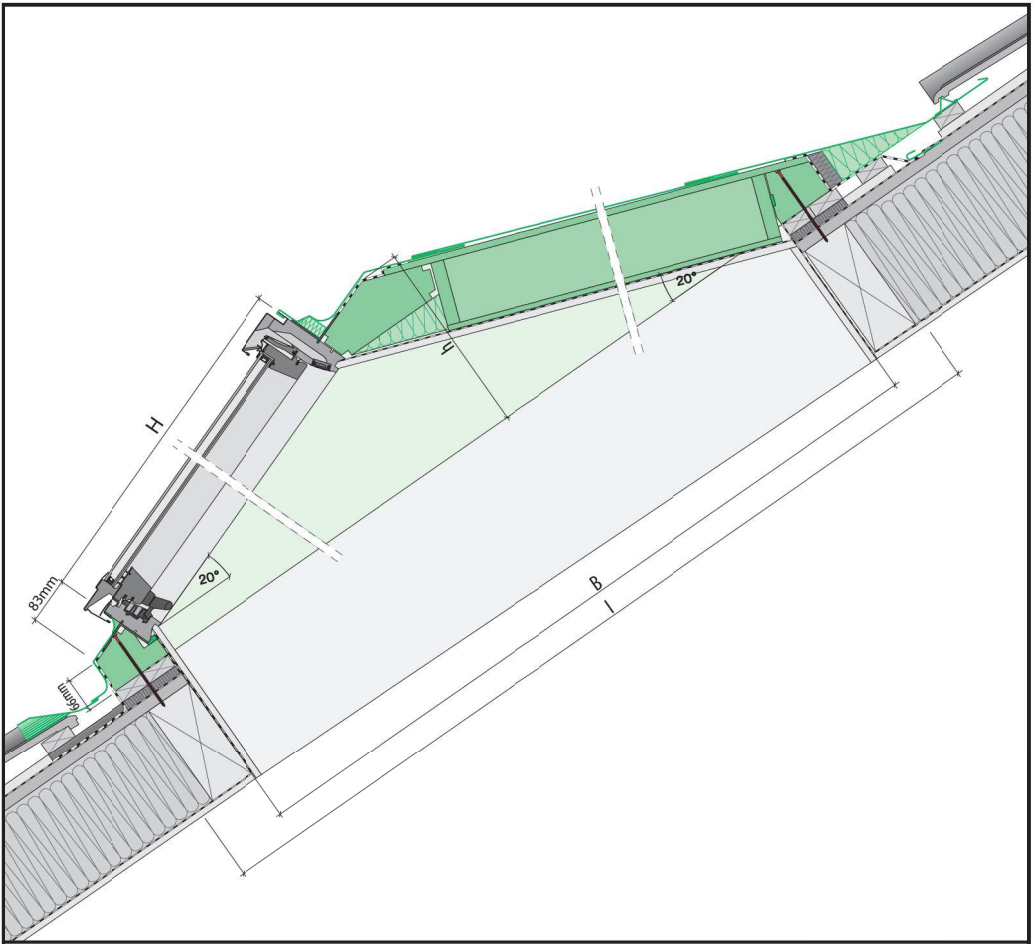

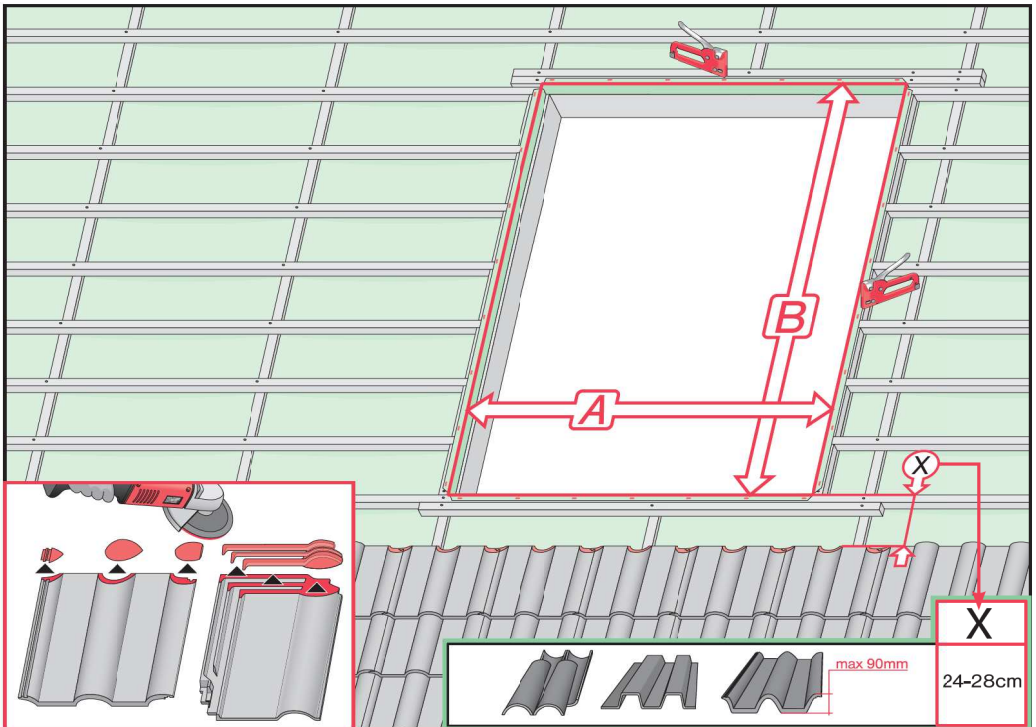
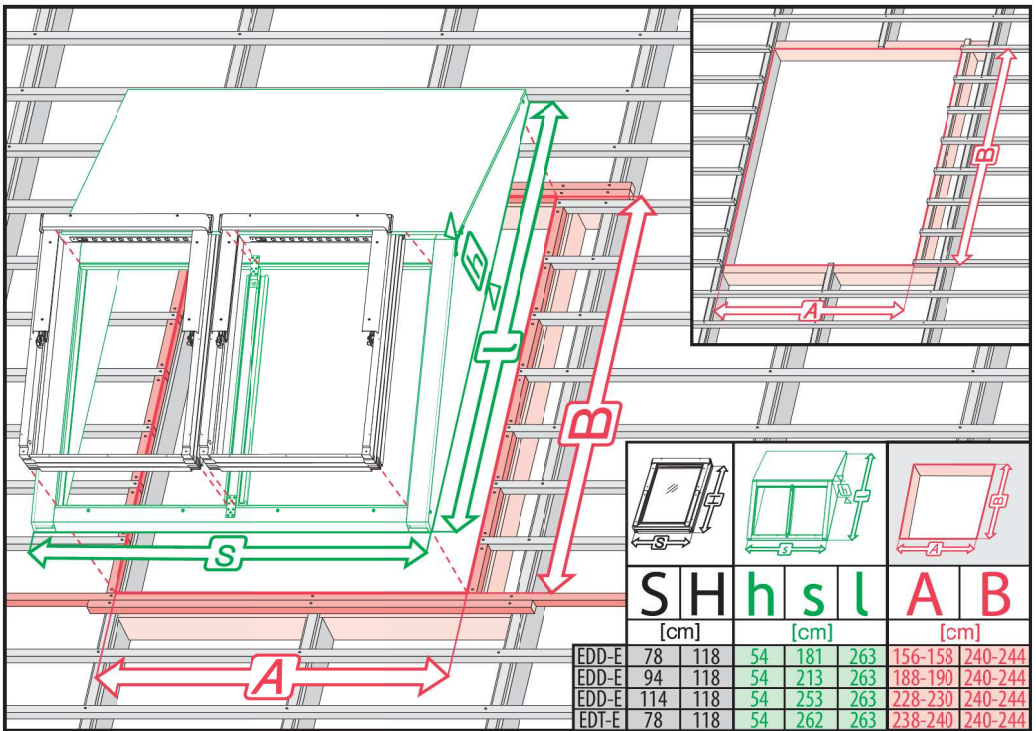

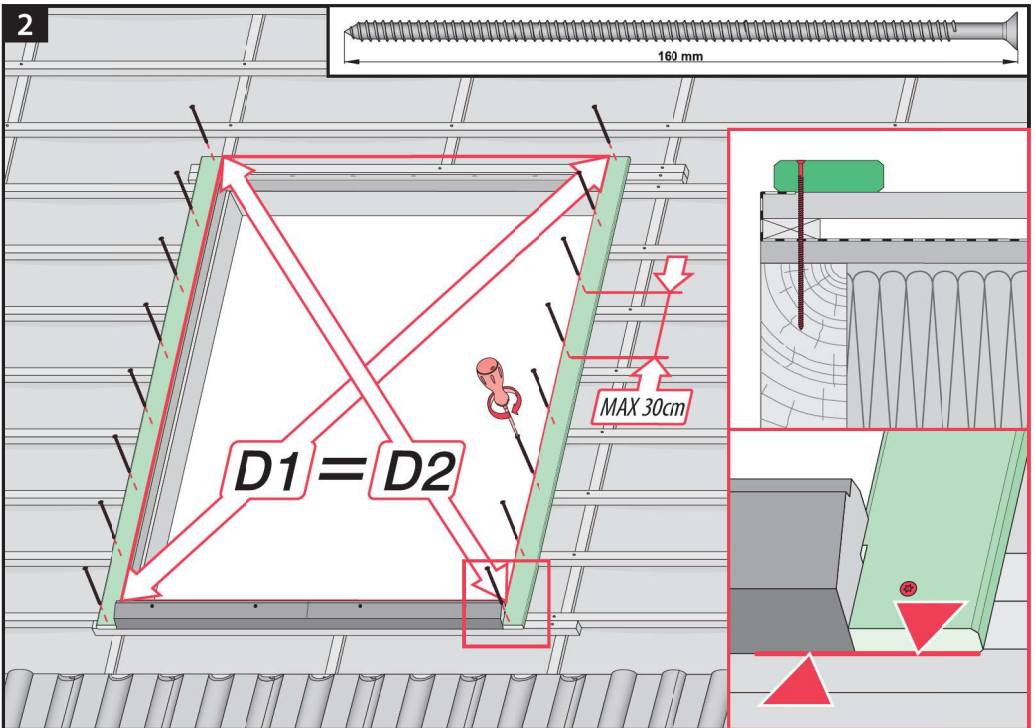
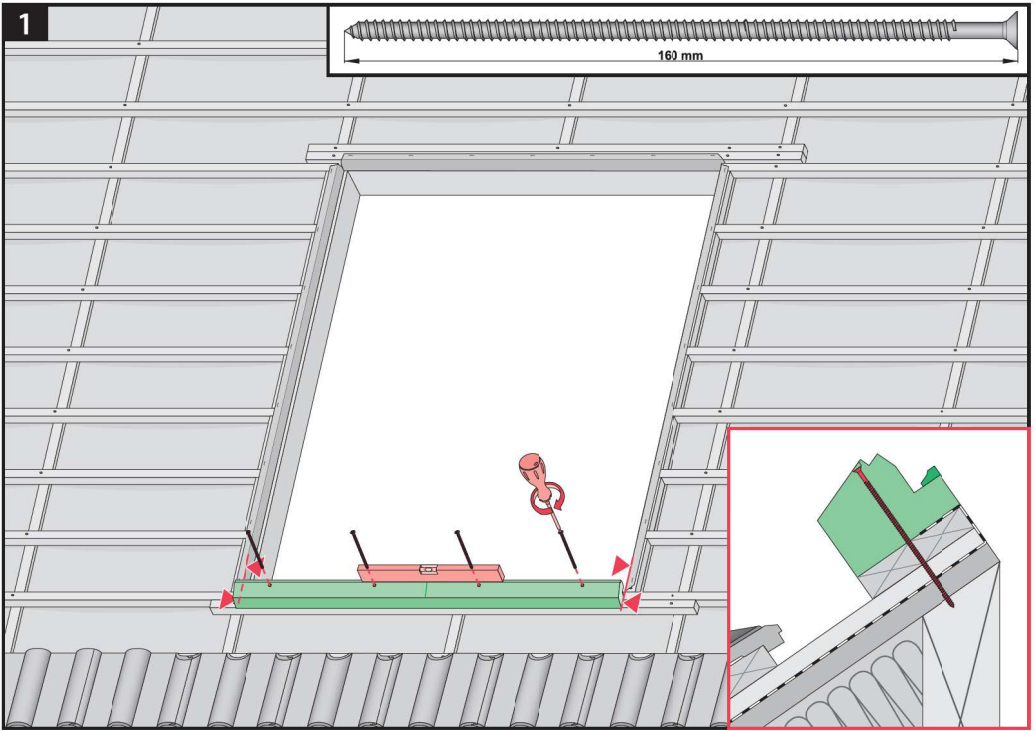

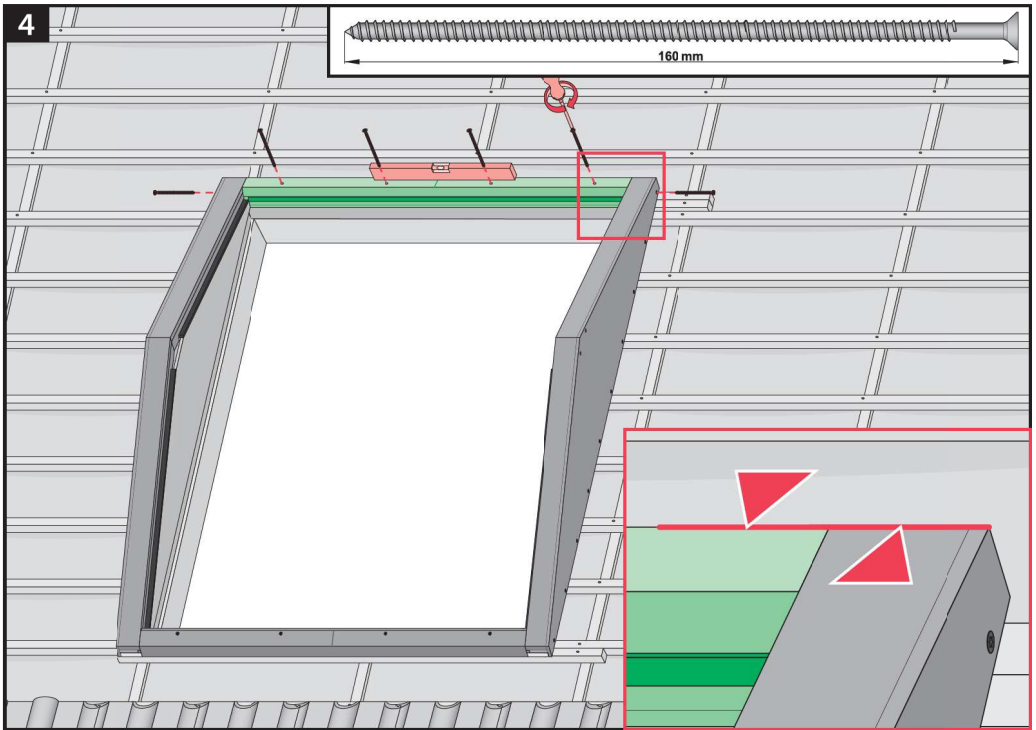
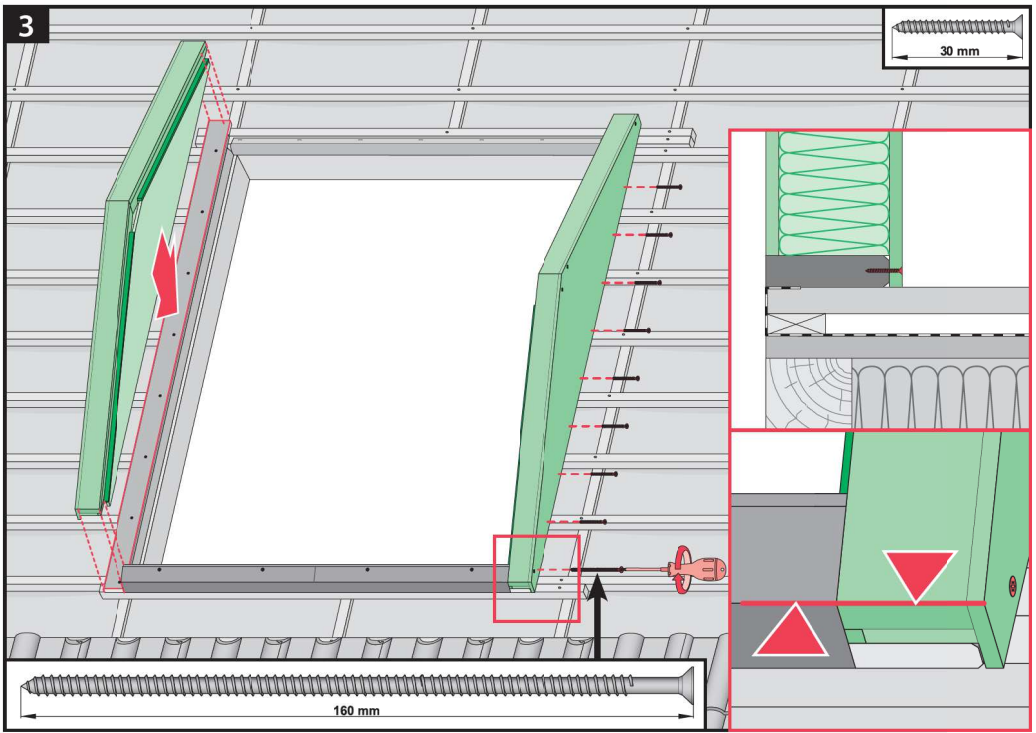

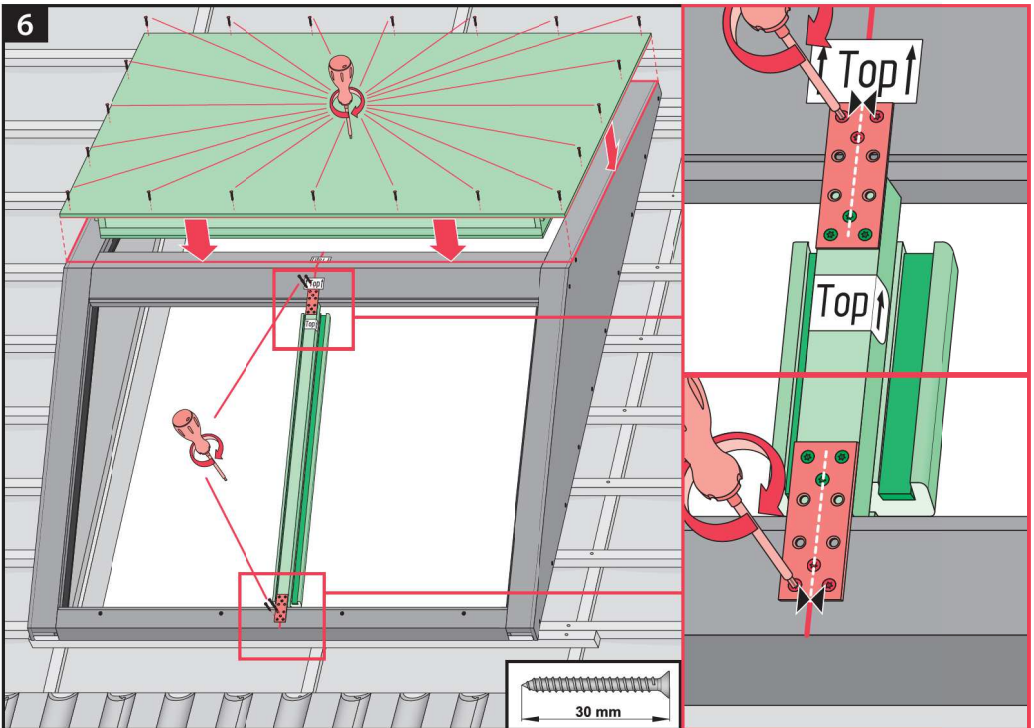
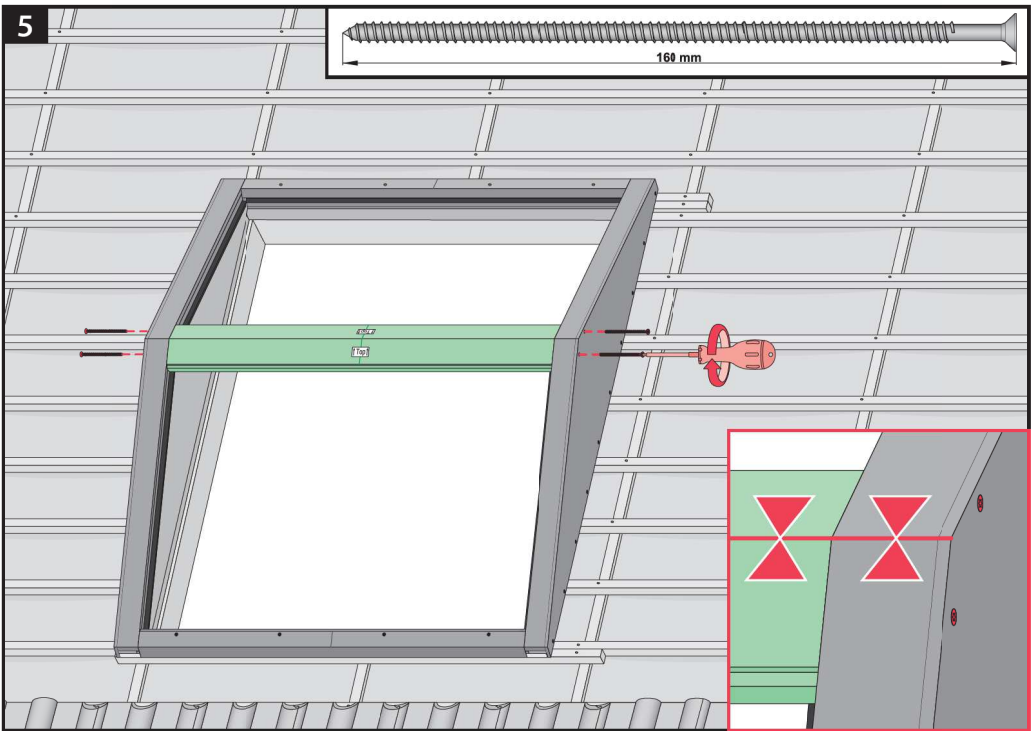

7

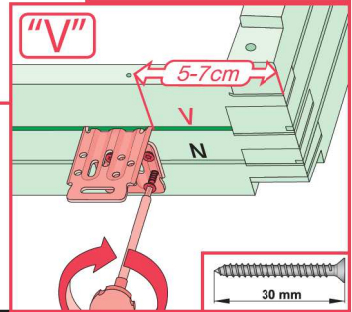
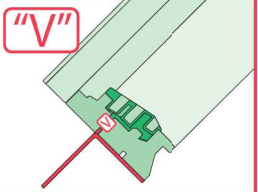
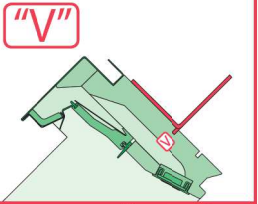
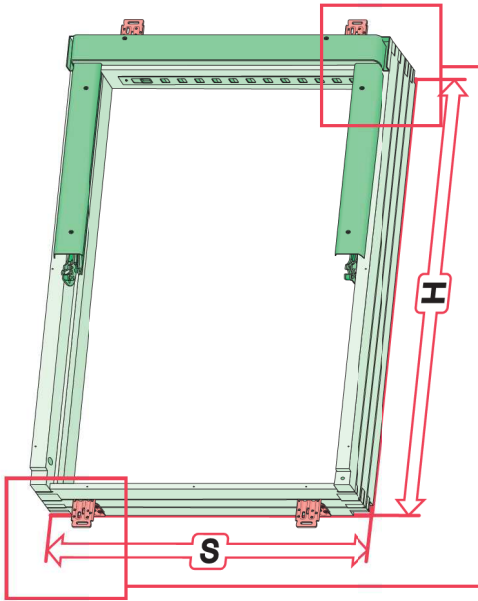
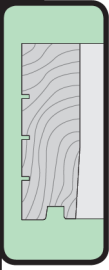

7*

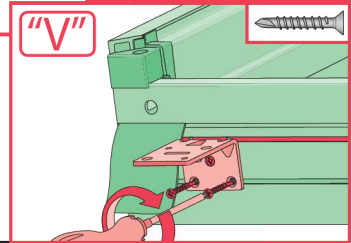
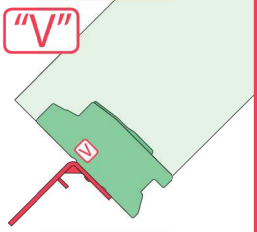
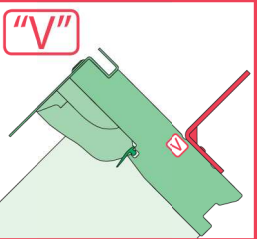
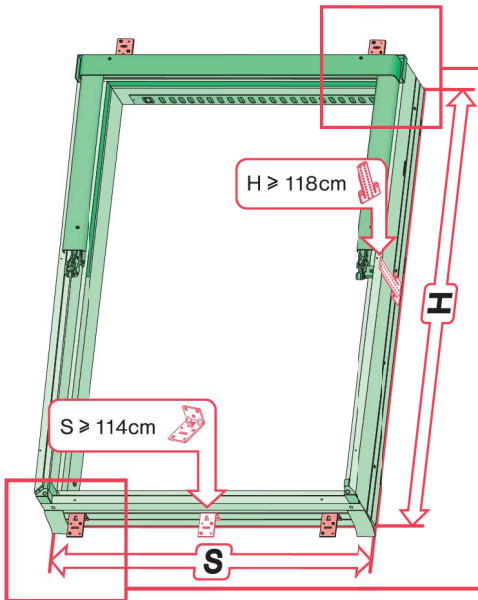
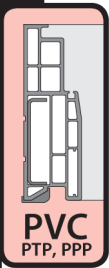

8* FTP-V ELECTRO

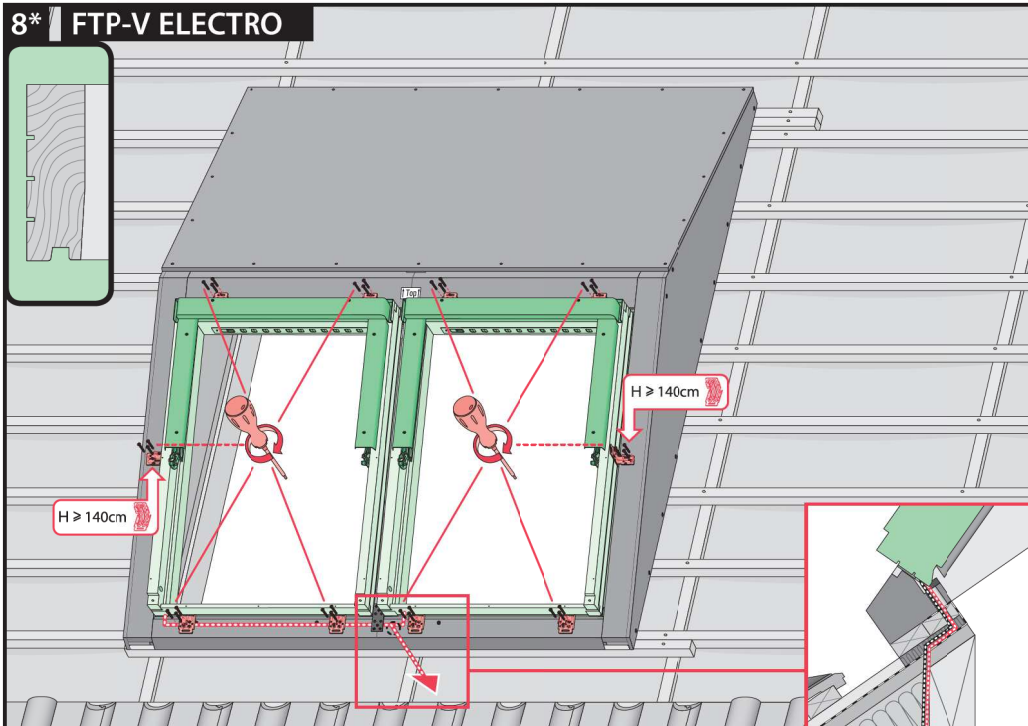
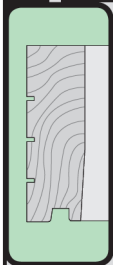

9

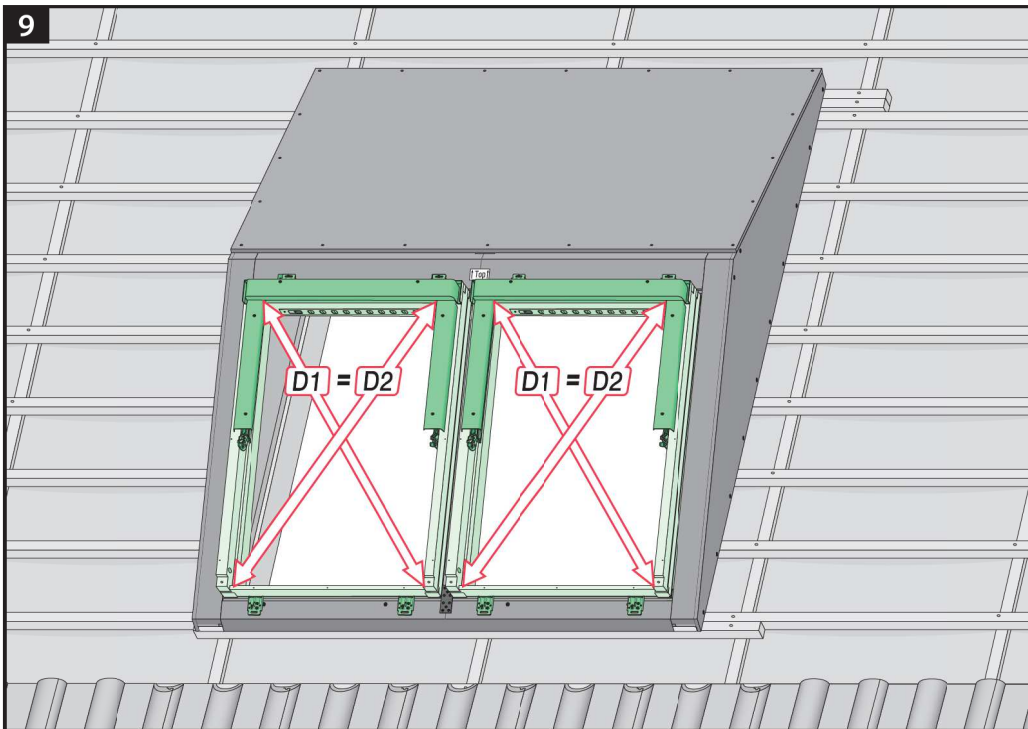

10

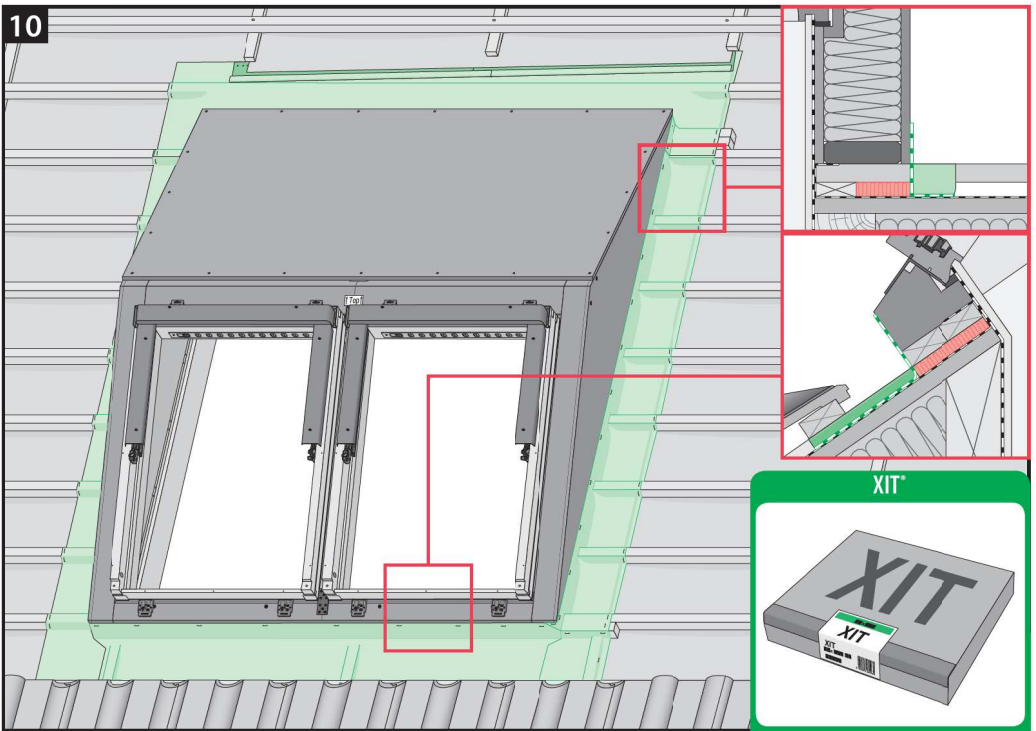

11

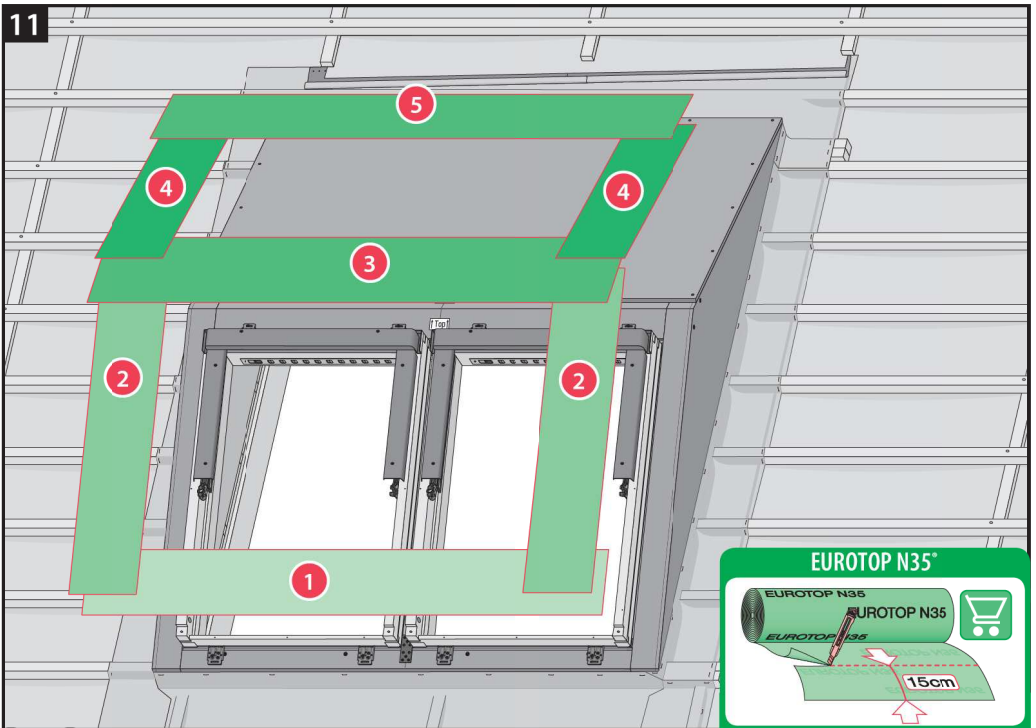

12

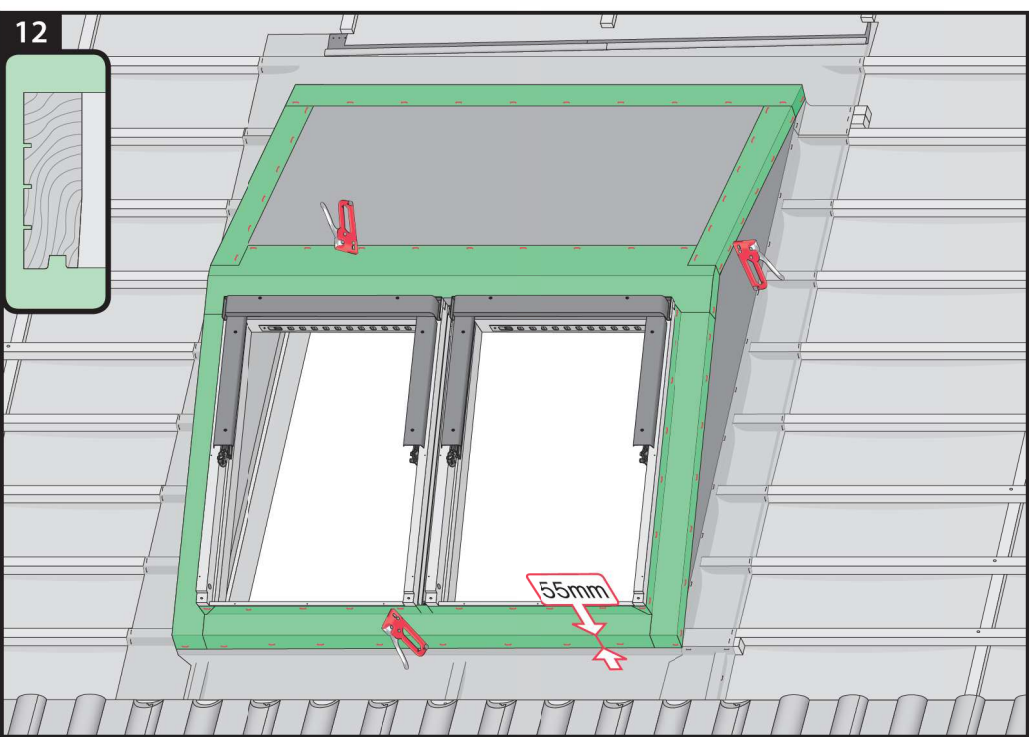

12*

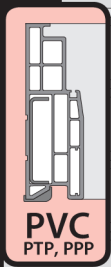

PVC
PTP, PPP

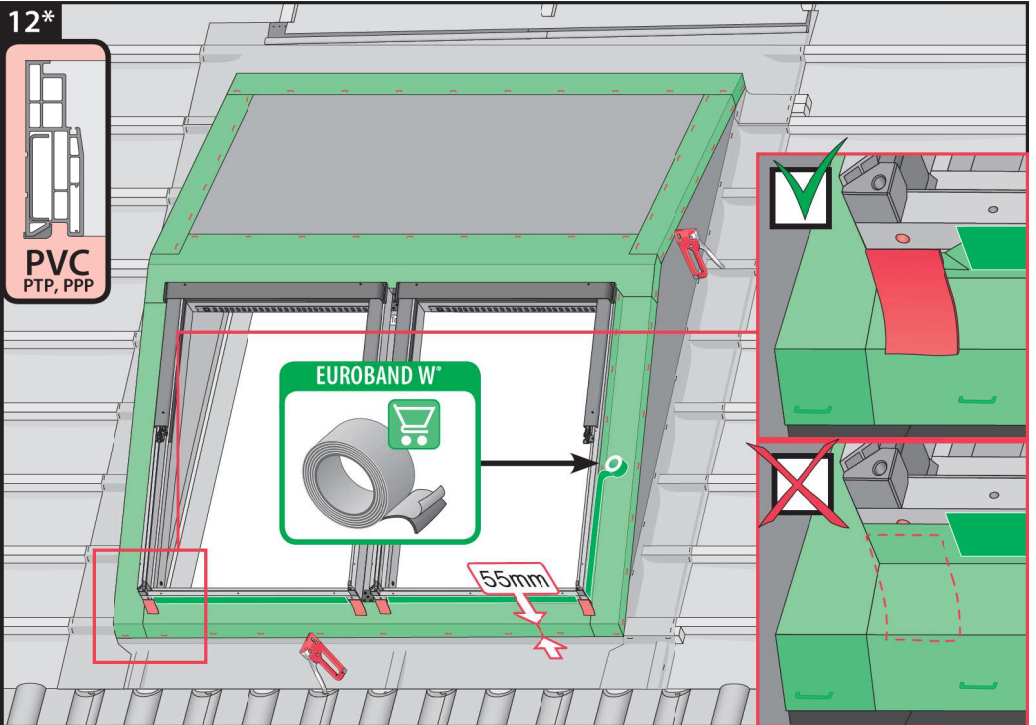

13a

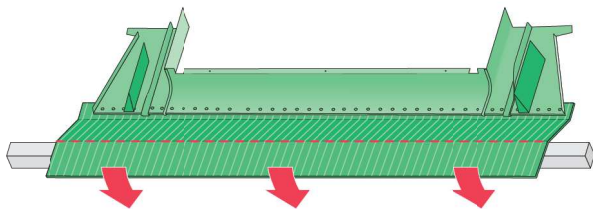
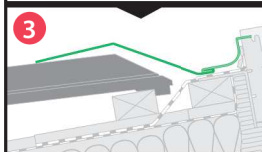
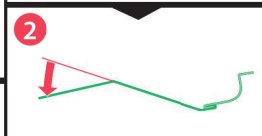
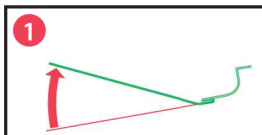
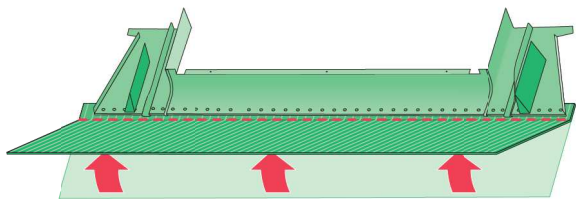

13b

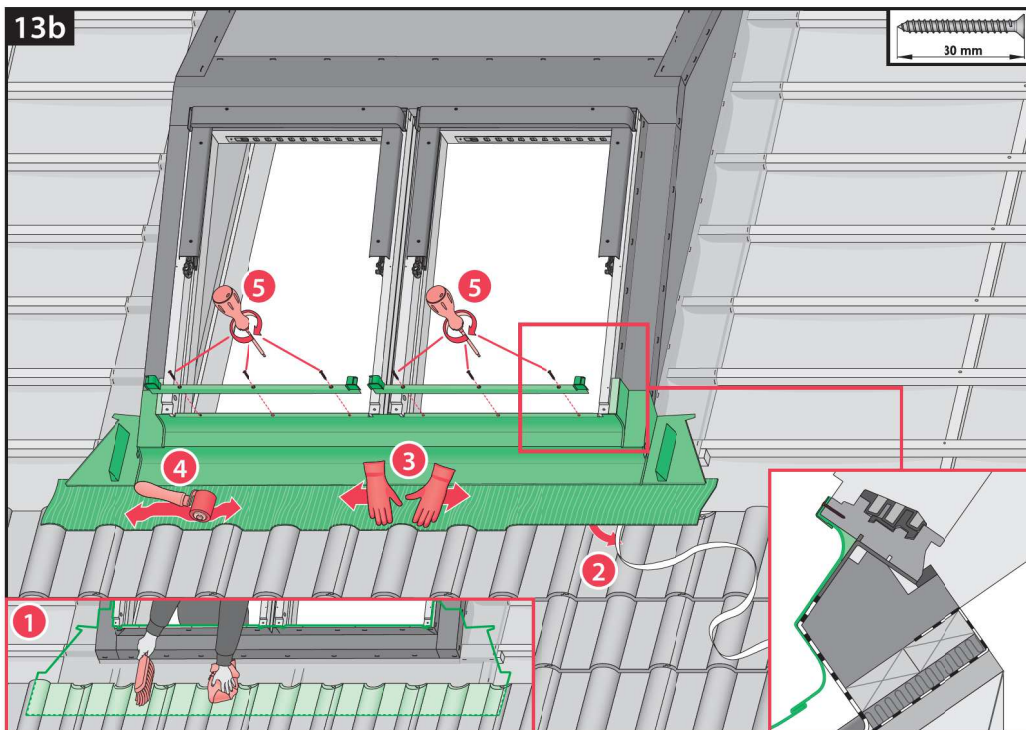

14a

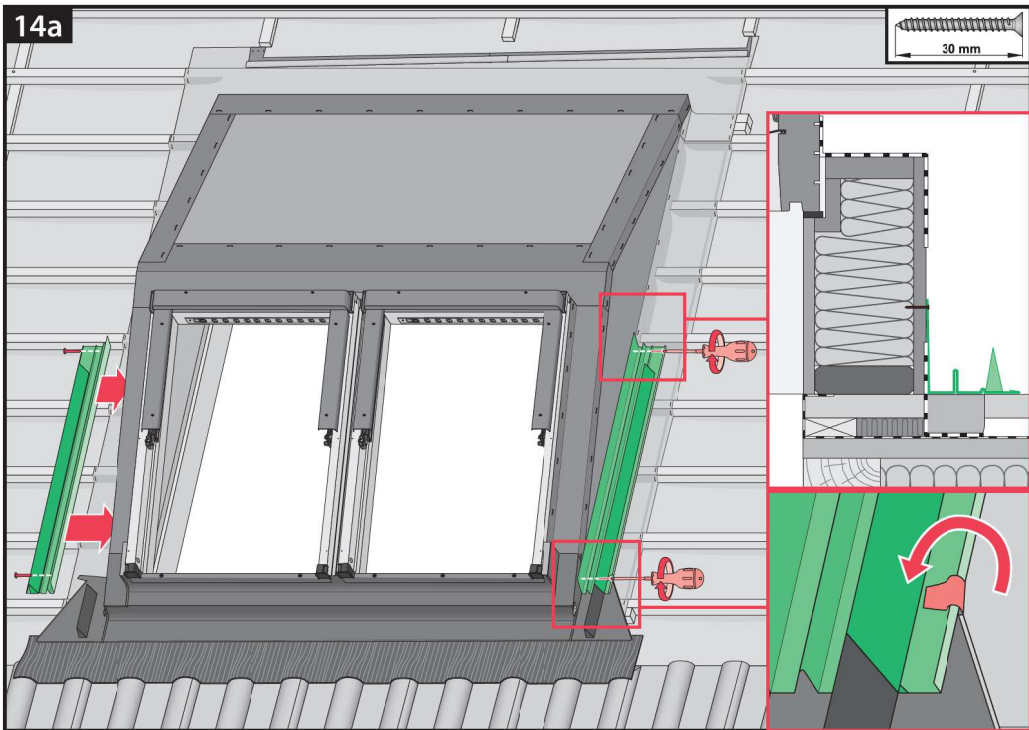

14b

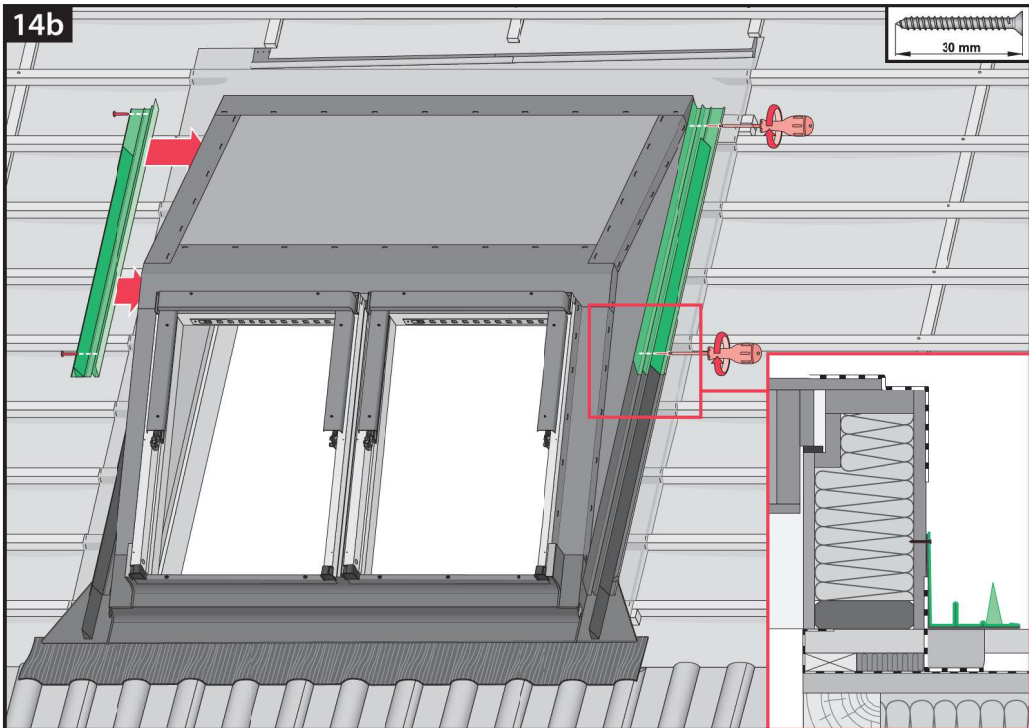

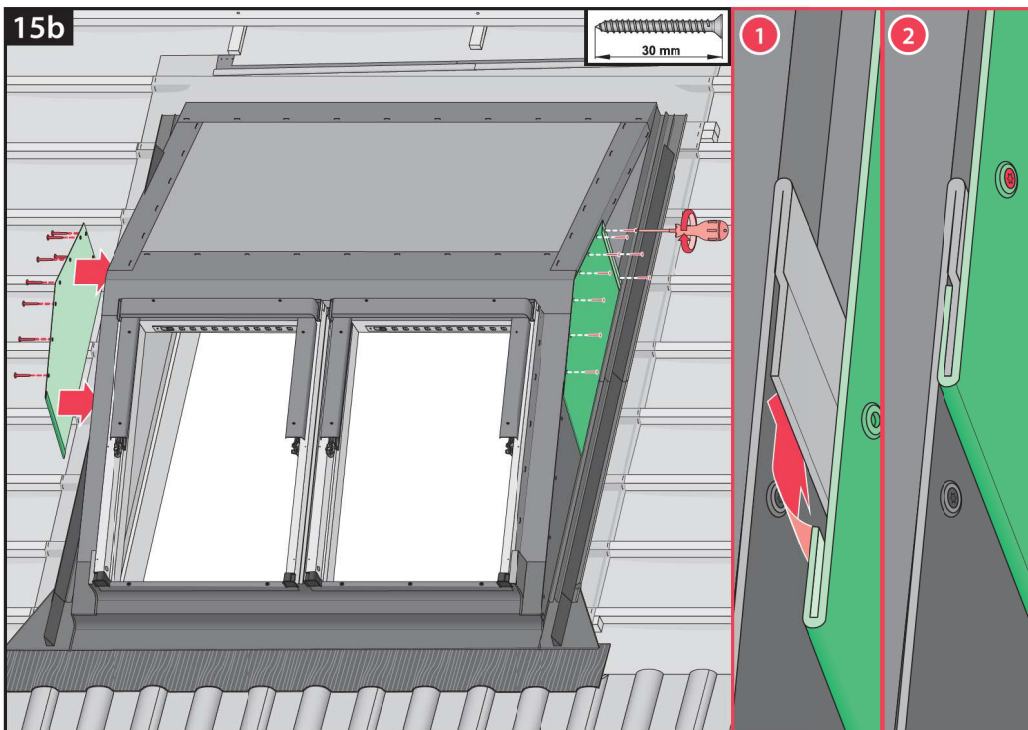
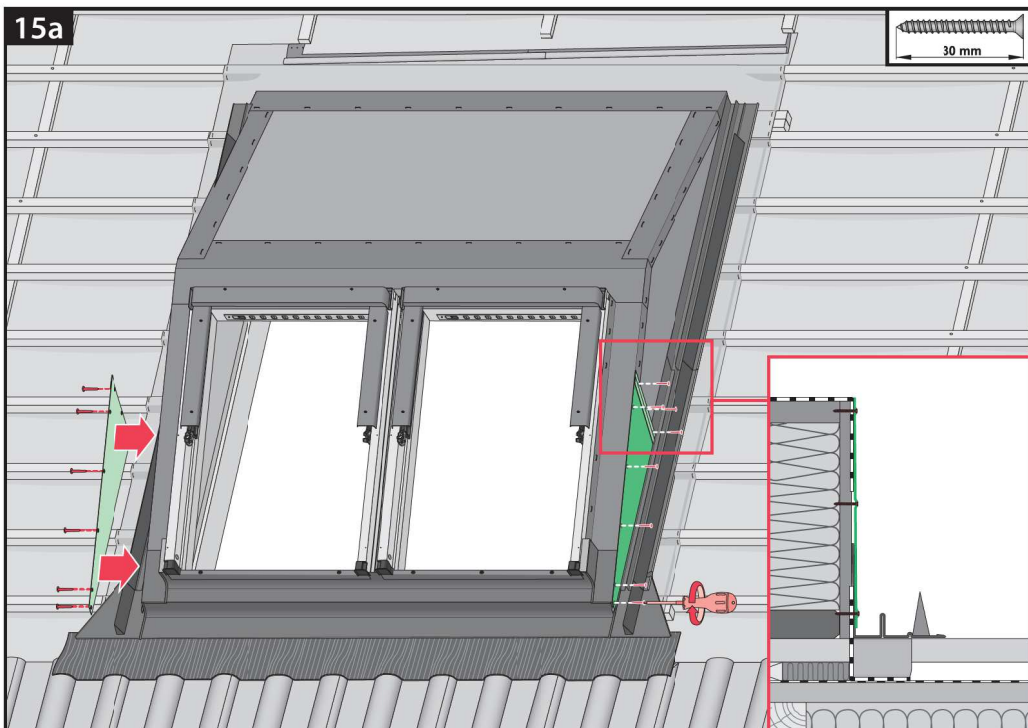

15c

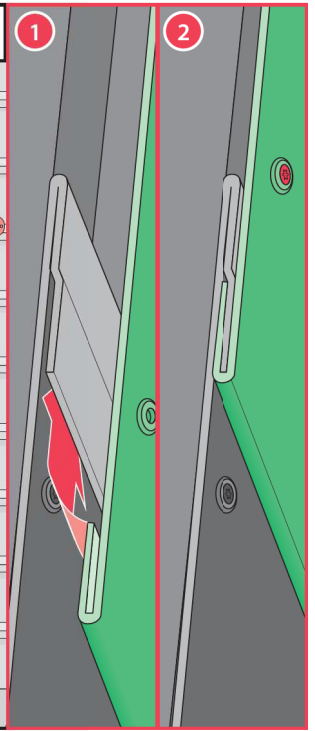
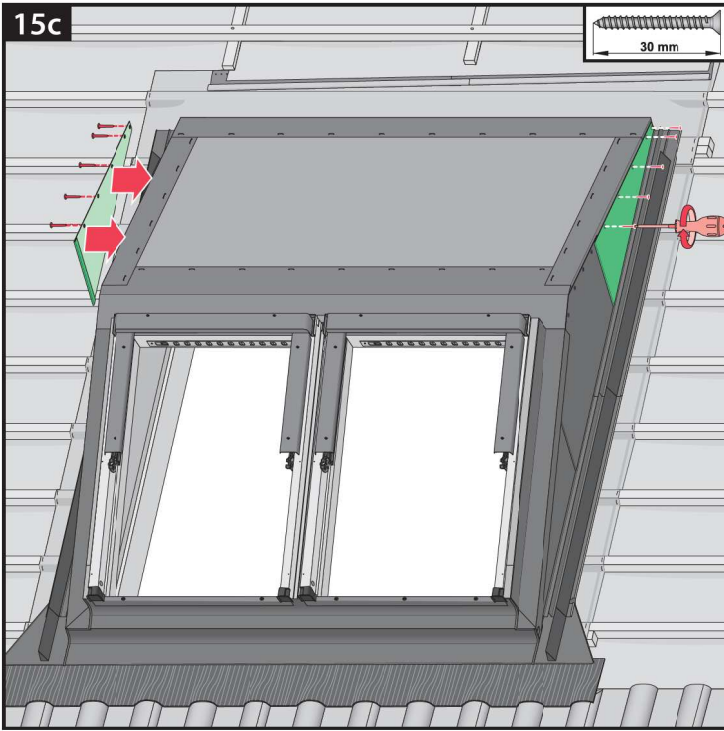

16

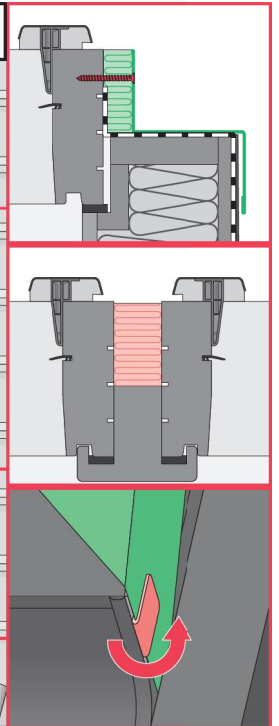
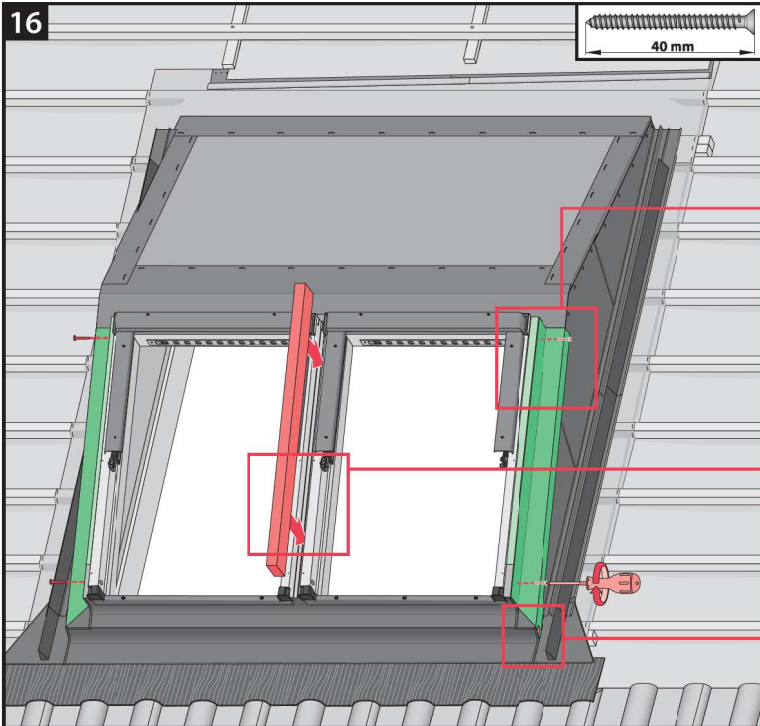

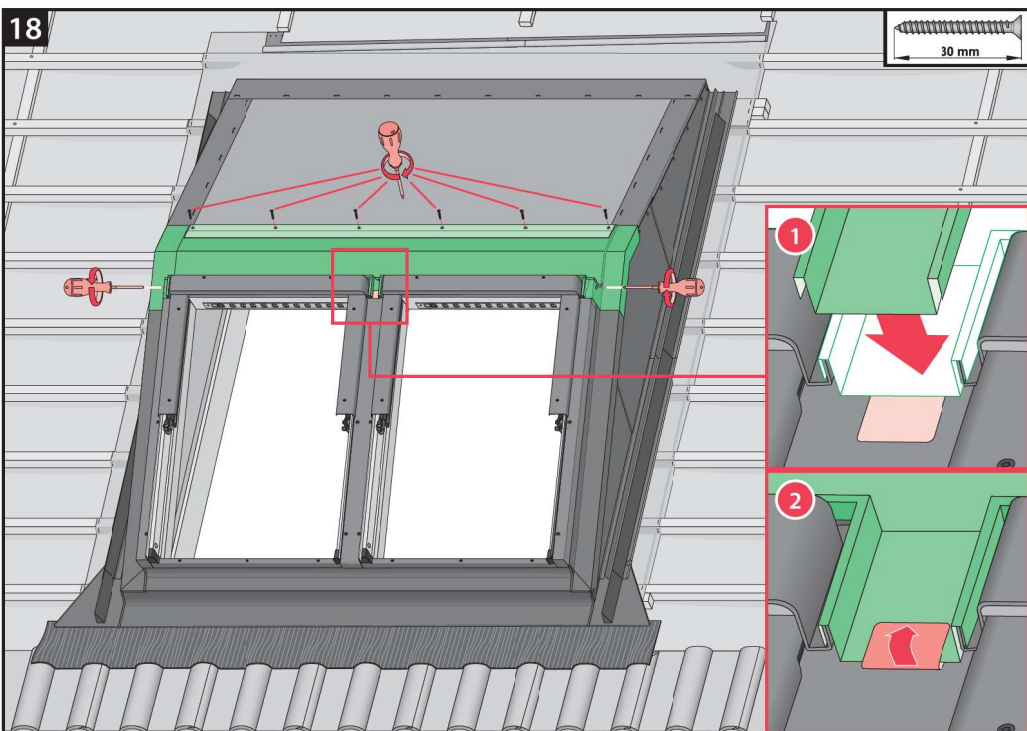
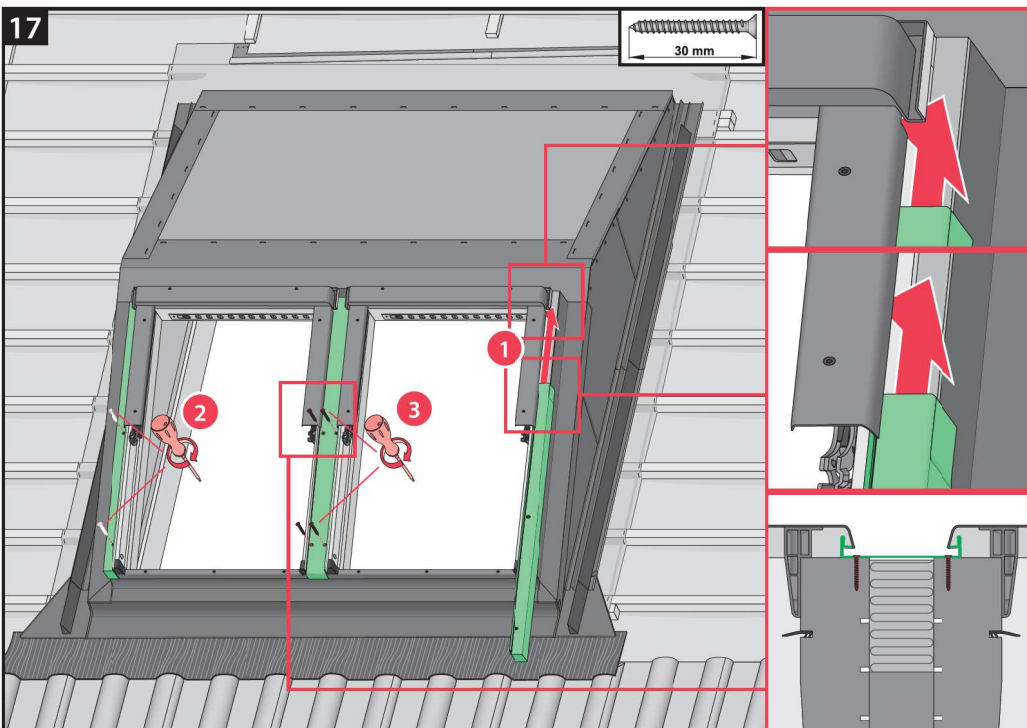

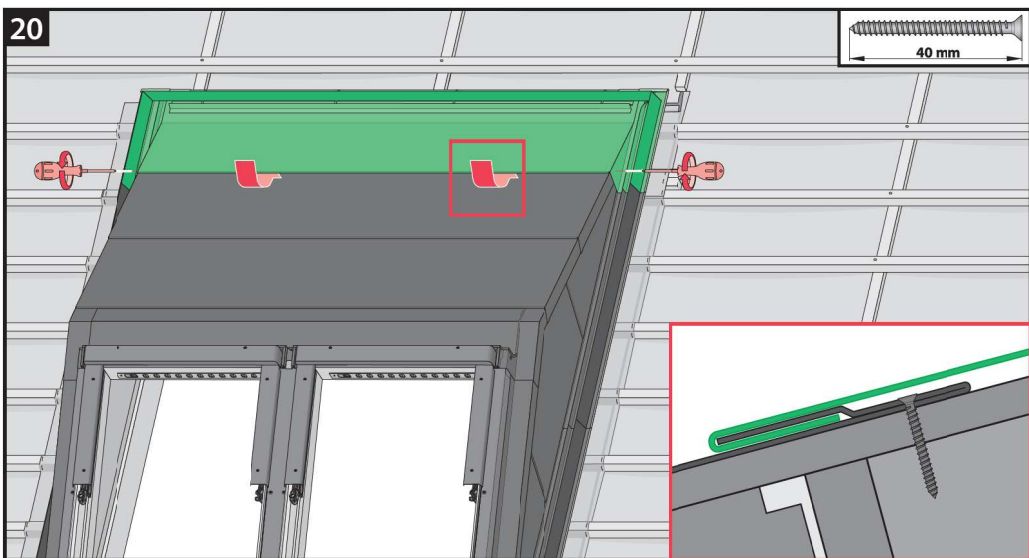
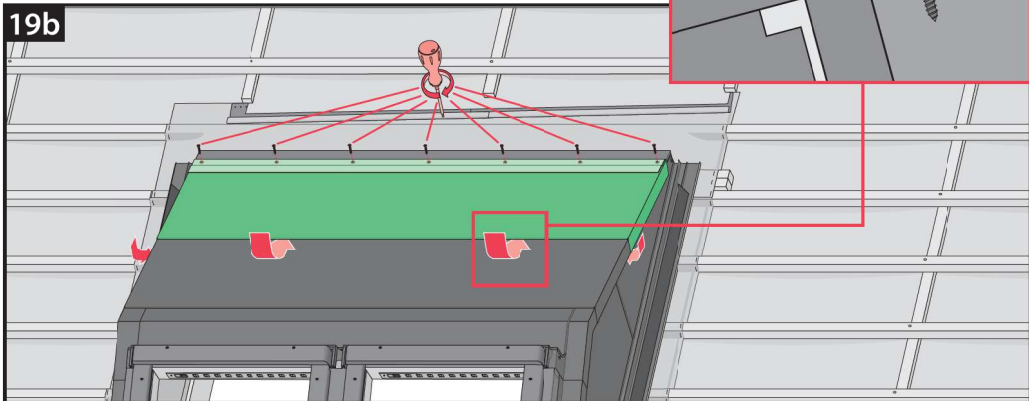
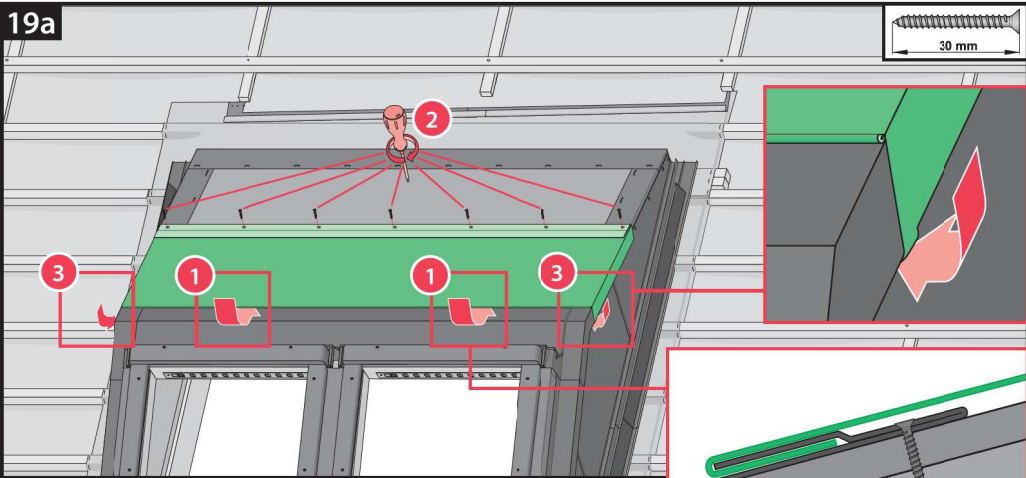

21

25 mm

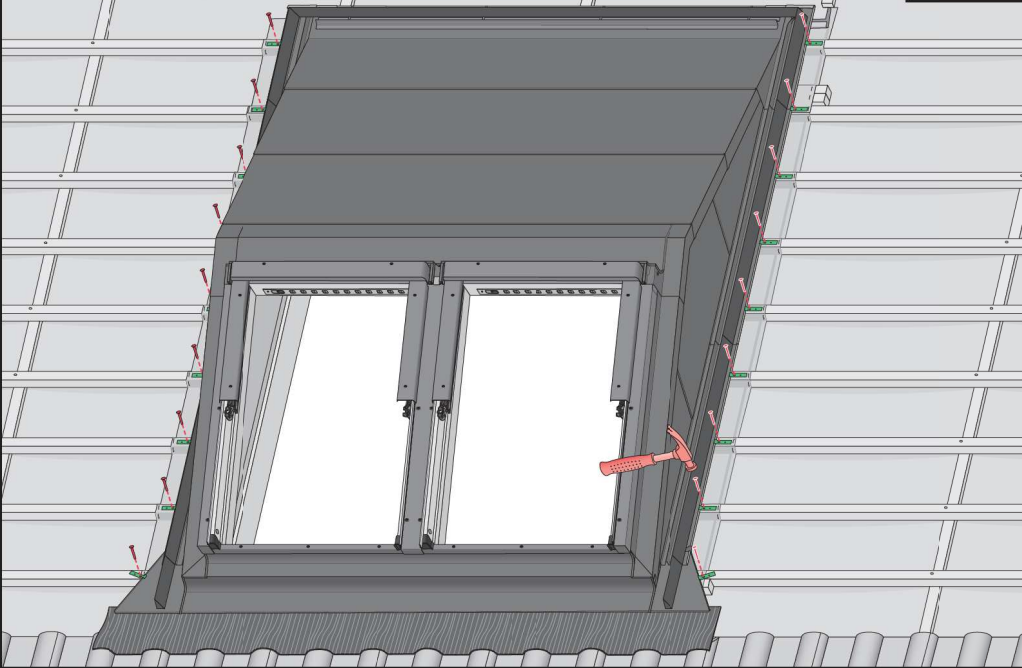

22

